

# Vivacious High-Tech Civil & Engineering Solutions Private Limited

Bio Waste To Bio Hydrogen  
Plant with Cylinder Filling

HIGH RECOVERY HIGH PURITY BIOGAS  
CONCENTRATION PLANT

+

BIO CNG TO HYDROGEN PLANT



Synopsis: Energy From Biowaste can be recovered by biologic metabolism of bio waste to Methane. Further, methane can be processed to Hydrogen using steam reforming process.

Project Head: Vivacious High-Tech Civil & Engineering Solutions Private Limited

Consultant: Finsen Ritter Technologies EU BV

Technology: Hybrid Membrane + VPSA separation of raw biogas to achieve high Methane purity + Steam Reforming of Bio Gas to Achieve Hydrogen



# OVERVIEW OF PRESENT TECHNOLOGIES

## Digestion Process Of Biomass

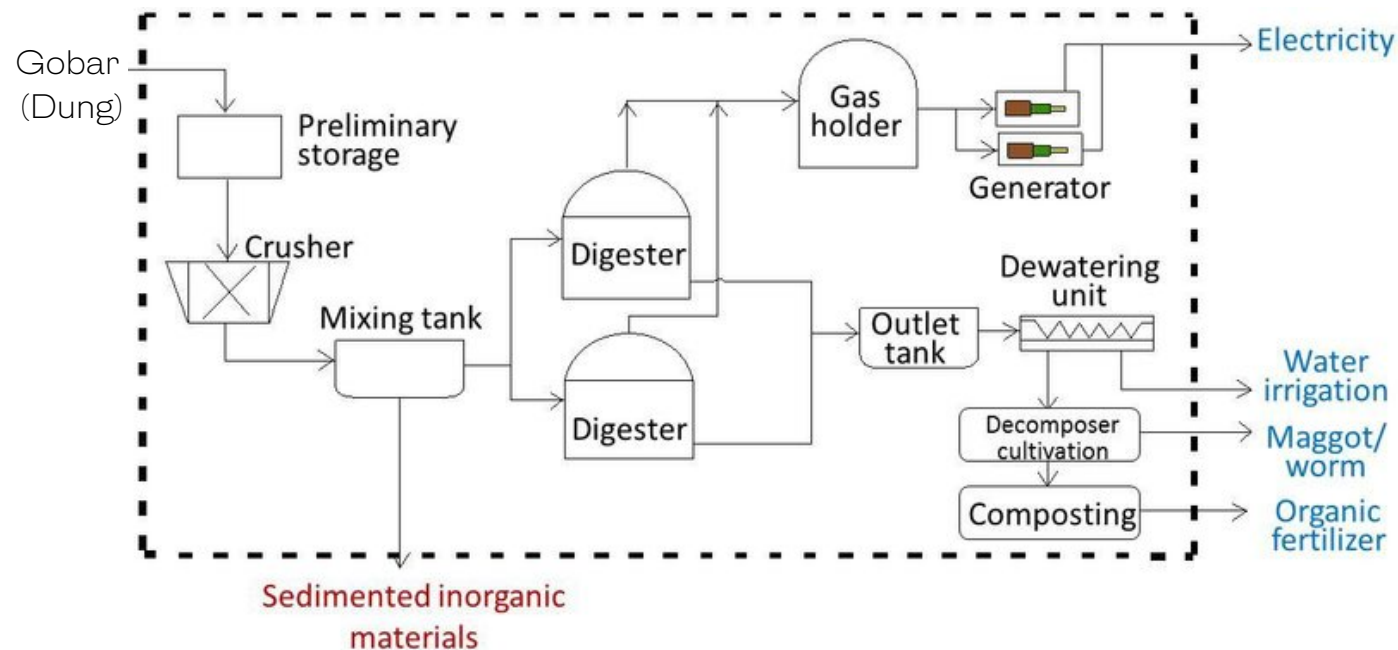

### Working Principle

- Water and dung is mixed in 1:1 ratio
- After water addition, homogenous mixture (Slurry) is prepared through agitator
- The slurry is transferred to the Anaerobic Digester
- In digester, dung degrades in presence of anaerobic bacteria to produce Biogas.

# OVERVIEW OF PRESENT TECHNOLOGIES

## Vacuum Pressure Swing Adsorption (VPSA) Gas Separation



### Working Principle

- Adsorbents like 5A Molecular Sieve selectively adsorb Methane and Carbon Dioxide
- On increasing the pressure Carbon Dioxide gets adsorbed on the surface of the Molecular Sieve
- Methane Passes through
- On purging cycle the Carbon Dioxide is flushed out

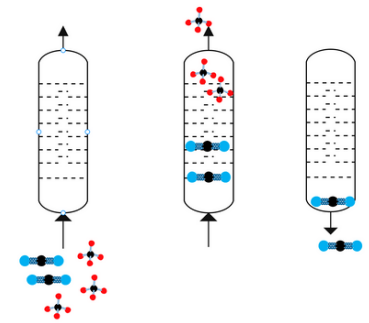

# OVERVIEW OF PRESENT TECHNOLOGIES

## Vacuum Pressure Swing Adsorption (VPSA) Gas Separation

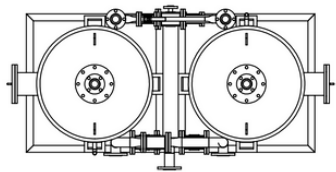

TOP

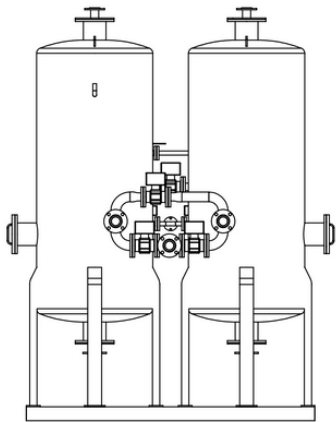

FRONT

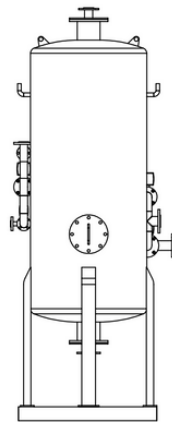

SIDE



### Advantages

- Reliability (96% availability)
- Ideal for large plants and landfill gas upgrading
- Only technology to remove Carbon Dioxide, Nitrogen and Oxygen in one stage
- Can upgrade biogas with high Oxygen and Nitrogen
- All pollutants removed (not released with the exhaust)
- Low consumables consumption



### Disadvantages

- Lower Recovery rate
- Venting of the usable product Methane in the exhaust cycle

# OVERVIEW OF PRESENT TECHNOLOGIES

## Membrane Air Separation

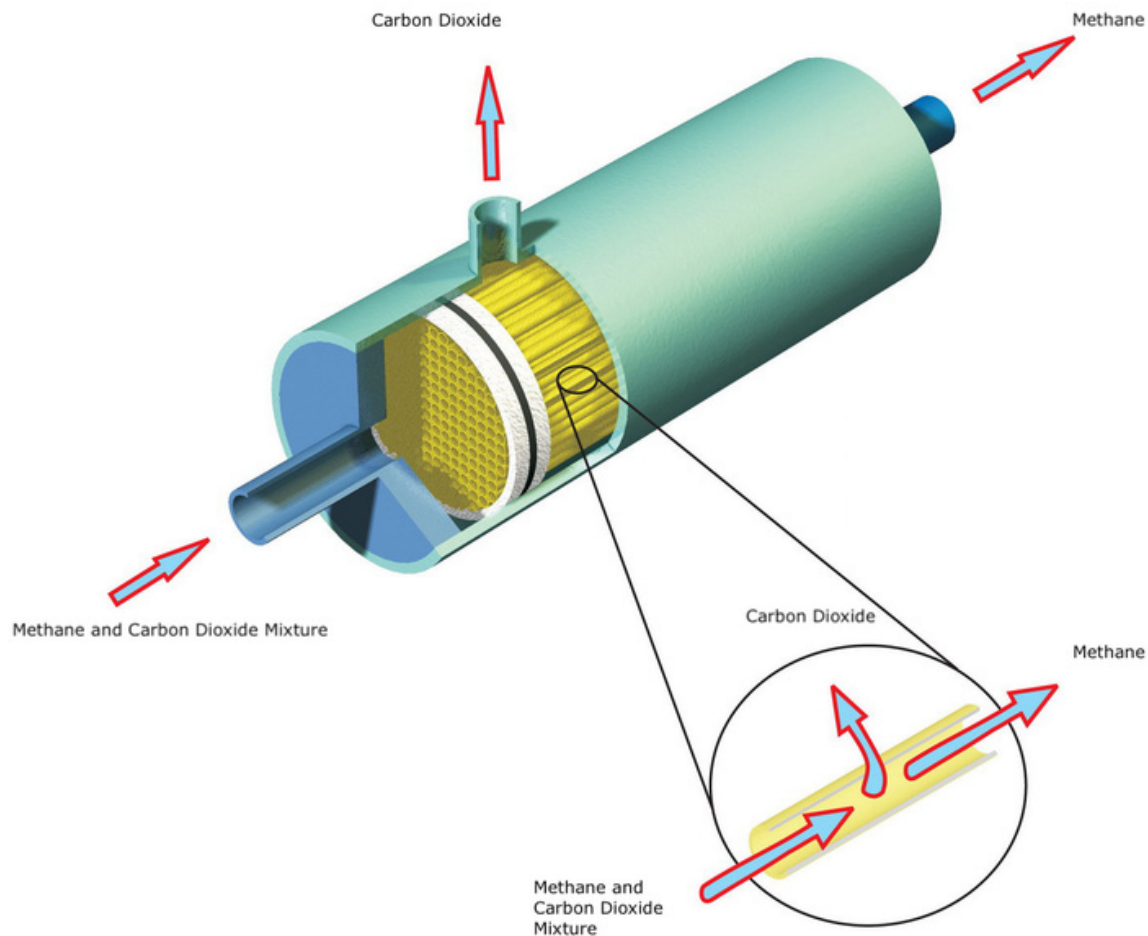

### Working Principle

- Membrane is selectively porous to methane and carbon dioxide
- Gas flow is sent in at a higher pressure to provide driving force (typical operating pressure is usually between 10-20 bar)
- Two types of membranes for biogas/natural gas separation, cellulose acetate (CA) spiral wound and polyimide (PI) hollow fiber membranes

# OVERVIEW OF PRESENT TECHNOLOGIES

## Membrane Air Separation



### Advantages

- High methane yield of up to 99,5%,
- Excellent modularity and turndown capacity
- Possible elimination of exhaust treatment with high recovery three stage membrane configuration (extremely low methane slip, less than 1% possible)
- Ideal for small to medium plants from 10 to 1.400 NCMH, easily scalable
- Excellent energy efficiency for upgrading (<0.2 kWh/Nm<sup>3</sup> crude biogas, <0.4 kWh/Nm<sup>3</sup> biomethane)
- Ease of maintenance



### Disadvantages

- Higher Capex
- Less reliability in case to get very high purity of methane

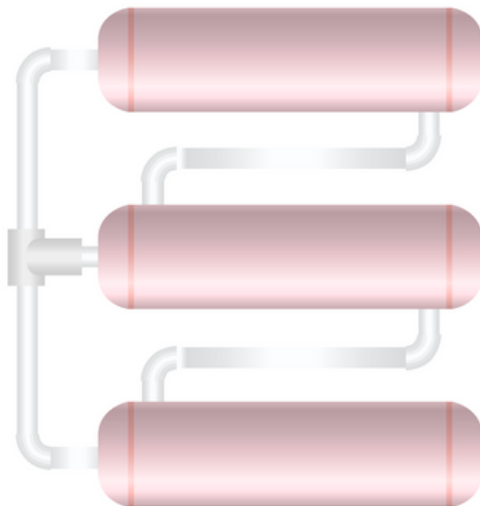

## ADAPTATION OF THE BEST FEATURES OF BOTH THE TECHNOLOGIES

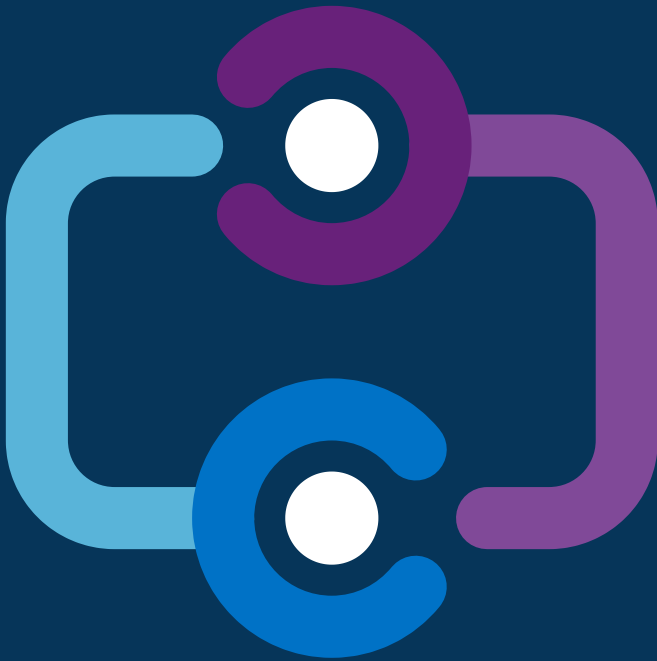

# WE PROPOSE HYBRID PLANT OF MEMBRANE + VPSA SEPARATION OF RAW BIOGAS TO ACHIEVE HIGH METHANE PURITY

- Reliability and long life of a PSA
- Modularity and turndown capability of membranes
- Excellent flexibility and overall system performance
- Excellent recovery of methane (99%)
- High gas purity (99%) - if required
- Oxygen / Nitrogen removal - if required
- Competitive investment (capex)
- Lower overall operating costs (opex) due to VPSA

# P&ID DIAGRAM OF 5 STAGE MEMBRANE + VPSA METHANE CONCENTRATION PLANT

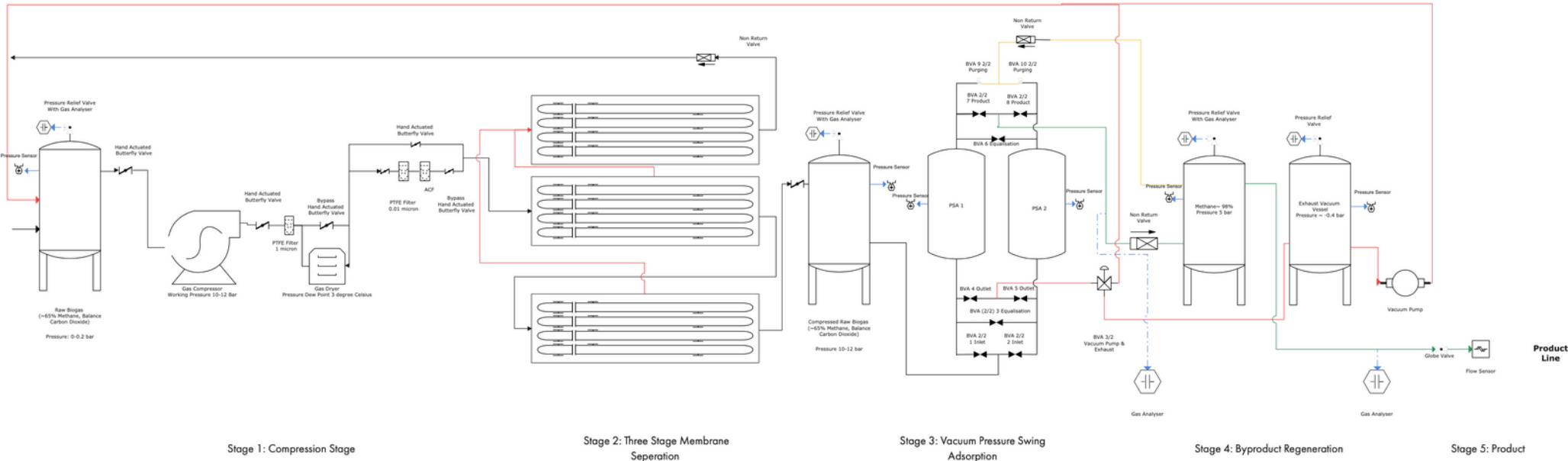

Stage 1: Compression Stage

Stage 2: Three Stage Membrane Separation

Stage 3: Vacuum Pressure Swing Adsorption

Stage 4: Byproduct Regeneration

Stage 5: Product

	Title: P&ID Diagram for Methane Concentration Plant (1000 Nm <sup>3</sup> /hr Plant)
	Date: 07/10/2021
Technology: Hybrid Membrane + Vacuum Pressure Swing Adsorption	Approved By: Aniket Awasthi

Serial	Item	Remark
1		Ball Valve With Actuator
2		Globe Valve
3		Gas Analyser
4		Pressure Sensor
5		Flow Sensor
6		2/2 Ball Valve with Actuator
7		3/2 Ball Valve with Actuator
8		Frame Breather Valve NC
9		Product Line
10		Input Line
11		Exhaust Line
12		Sensor Line
13		Purging Line





# FINSEN RITTER GAS PLANTS

## KEY FEATURES OF FINSEN RITTER PROPOSED DESIGN



Energy Efficient Design per NMCH gas separated



High Reliability due to Stainless Steel Grade 304 Piping

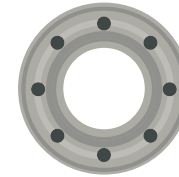

Completely Flange end pipe coupling



Fully Automated PLC Controlled Plant



SCADA integration



Safe design with all electronic sensors and redundant control systems



Completely in house design of plant providing reliable after sales support

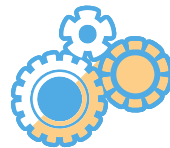

Use of state of the art quality equipment like Siemens PLC, Festo Valves and fittings, SS 304 Piping, Honeywell sensors



Very high recovery rate of 99% allowing almost all Methane to be recovered with minimal wastage

# METHANE STEAM FORMING

# HYDROGEN FROM METHANE

- Steam reforming is the most widespread process for the generation of hydrogen-rich synthesis gas from light carbohydrates.
- The feed materials natural gas, liquid gas or naphtha are endothermically converted with water steam into synthesis gas in catalytic tube reactors.

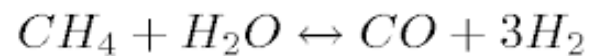
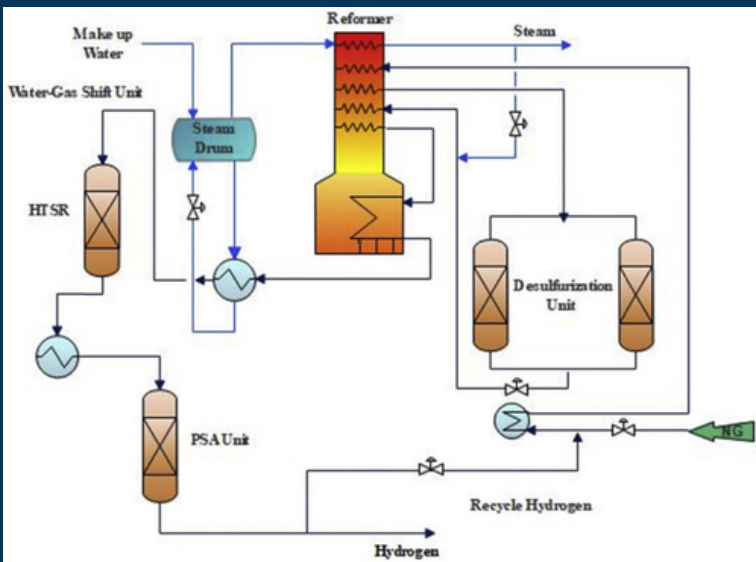
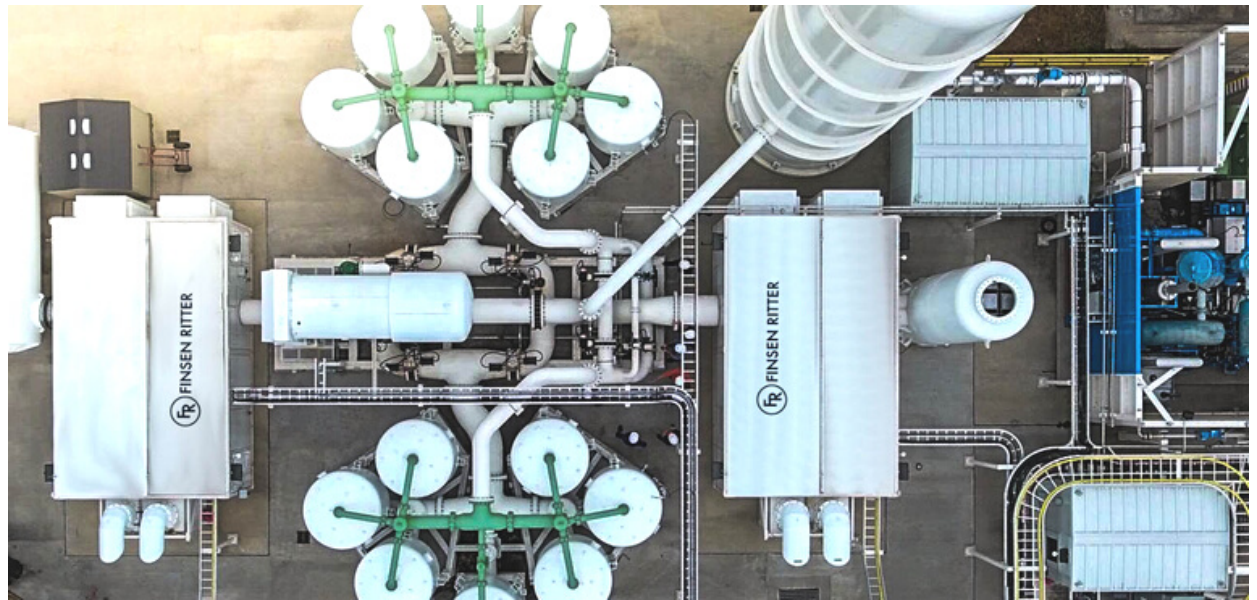

$$\Delta H_{295} = -206 \text{ kJ/mol}$$

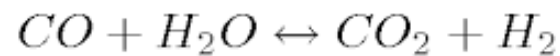

$$\Delta H_{298} = -41 \text{ kJ/mol}$$

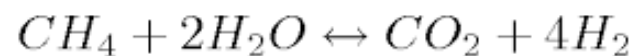

$$\Delta H_{298} = 165 \text{ kJ/mol}$$

# ABOUT THE COMPANY

WE SPECIALISE IN INDUSTRIAL TURNKEY SOLUTIONS. WE HAVE DEVELOPED OUR IN-HOUSE TECHNOLOGIES IN THE DESIGN, SUPPLY, INSTALLATION AND TESTING OF CHEMICAL AND GAS PLANTS.

WE HAVE BUSINESSES IN EUROPE AND INDIA. OUR DESIGN CENTRE IS IN AMSTERDAM, THE NETHERLANDS AND THE MANUFACTURING CENTRE IN INDIA.

WE HAVE EXPERTISE IN OXYGEN, NITROGEN, HYDROGEN, ANA, UVGI EQUIPMENT, WATER TREATMENT, BREWING EQUIPMENT, SOLAR POWER PLANT, MILK CHILLER PLANTS, CHLORINATION PLANT, BIOGAS PLANT, BIO CNG PLANT, NOISE MONITORING DEVICES ETC

WE FOLLOW THE STATE OF THE ART INDUSTRY 4.0 STANDARDS ACROSS ALL OUR EQUIPMENT AND PLANTS DELIVERING THE BEST OF EQUIPMENT TO OUR CLIENTS.

REGISTERED ADDRESS (EU)  
FINSSEN RITTER TECHNOLOGIES EU BV  
KABELWEG 57  
1014 BA, AMSTERDAM  
KVK-NUMBER 85599956  
+31 622633280

[WWW.FINSSENITTER.COM](http://WWW.FINSSENITTER.COM)

EMAIL US: [CONTACT@FINSSENITTER.COM](mailto:CONTACT@FINSSENITTER.COM)



IMPETUS

